



## Ozone Plus EN3 (Standard Strength Hydraulic Patch)

Ozone Plus is the latest and one of the most innovative Bottom Patch fittings for frameless glass doors that comes with an in-built hydraulic system. The products under this range do not require any cavity to be made in the floor for installation. Hence, no digging, no cutting of the floor is required, making the installation quick & easy.

The Ozone Hydraulic Patch Fitting is surface mounted directly to the floor making it easy to install and thus a more cost effective option for doors. Direct mounting to the floor is done with an adjustable base plate and this removes the need for pre-casting or cutting floor spring boxes, which is a slow messy process creating concrete dust and potentially weakening the floor slab.

The Ozone's innovation is in the hydraulic closer mechanism which fits within the patch fitting, and allows closing adjustment like a floor spring. The closer mechanism can be non hold open or be 90 degree hold open.

The patch fitting is slightly larger than a normal patch fitting at 190 x 70mm, but does not look out of place when used in typical frameless glass entry. The patch fitting comes with a 304 satin stainless steel covers for internal use.

The Ozone Hydraulic Patch Fitting is suitable for internal doors up to 1000mm wide made from 8 to 12mm TEMPAFLOAT® Toughened Safety Glass (TSG) up to 100kg maximum weight.



### Key Features

- ▶ Suitable door weight: Max 100kg.
- ▶ Suitable door width: 750-1000mm.
- ▶ Suitable door thickness: 8-12mm TEMPAFLOAT® Toughened Safety Glass.
- ▶ Ambient temperature: 20°C - +50°C.
- ▶ Hold open 90° (Non Hold Open also available).
- ▶ No need to have the pre-set on the floor.
- ▶ Easy installation with base seat adjustable ±3mm backward and forward ±3mm left and right and 4° alignment adjustment.
- ▶ Double Action 150° Movement.
- ▶ 2 Stage Speed Adjustment.
- ▶ The Ozone Hydraulic Patch Fitting is a new innovation for self closing frameless internal glass doors.

### Types

- ▶ Ozone FH-100-HO – Hold open – 90 degree.
- ▶ Ozone FH-100-NHO – Non hold open.

### Material Finish

- ▶ Satin or Polished Stainless Steel.
- ▶ Powdercoated on request. Note: Powder coating is available in a wide range of colours with commercially available surface integrity warranties from 10 to 30 years.

### Scope of Use

- ▶ Designed for use in Germ and Bacteria Free environments such as hospitals and restaurants.
- ▶ Ensures no dust/water accumulation under the door or below the floorspring plate.
- ▶ Extremely useful in places requiring regular floor washing and mopping.

### Support Inquiries

- ▶ Metro Technical phone (09) 927 3000 or email [technical@metroglass.co.nz](mailto:technical@metroglass.co.nz)

## Ozone EN3 – FH100





SUITABLE FOR INTERNAL ONLY. MAXIMUM Door weight 100kg. Suitable for Door Width 750~1000mm.

Nominal Glass Thickness (mm)	MAXIMUM Door Heights Span (mm) for Wind Zones																		
	Internal 0.5kPa			Low 0.72 kPa			Medium 0.96 kPa			High 1.36 kPa			Very High 1.76 kPa			Extra High			
	H	W	Suits	H	W	Suits	H	W	Suits	H	W	Suits	H	W	Suits	H	W	Suits	
8mm TEMPAFLOAT®		1000	Yes																
10mm TEMPAFLOAT®	2400	1000	Yes																
12mm TEMPAFLOAT®	2800	1000	Yes																

## HINGED AND PIVOT DOORS

## Ozone EN3 (Standard Strength Hydraulic Patch)



Product	Model	Sizes mm	Finish	Material	Type	Application	Area
<b>FH100 OZONE EN3</b> (Standard Strength Hydraulic Patch) 	301076	90 DEGREE HOLD OPEN	SS	304/316 STAINLESS STEEL	HYDRAULIC FLOOR MOUNTED PATCH FITTING	PIVOT DOOR HINGE DOOR	Internal & External 
	301077	NON HOLD OPEN	SS				
	301762	90 DEGREE HOLD OPEN	PSS				
	301763	NON HOLD OPEN	PSS				
		GLASS THICKNESS: 8-12mm	ON REQUEST: POWDERCOAT				
<b>FH100 OZONE EN3 COVER PLATE</b> 	301075	186x71mm	SS	316 STAINLESS STEEL	COVER PLATE	REPLACEMENT PARTS	Internal & External
<b>BASEPLATE &amp; COVERS To Suit Ozone FH100 / FH105SSS</b> 	301640	110x47mm	SS	316 STAINLESS STEEL	BASE PLATE AND COVERS	REPLACEMENT PARTS	Internal & External
<b>PATCH FITTING, 65 x 186 L Shape Plate for FH100 SSS</b> 	301074	65X186X2.5mm	SS	316 STAINLESS STEEL	L SHAPE PLATE	PATCH FITTING	Internal & External

(Standard patch fittings can accommodate 10-12mm glass only)



# FRAMELESS COMMERCIAL DOORS

## Installation / Fitting Instructions

### Ozone Plus EN3 Hydraulic Closers

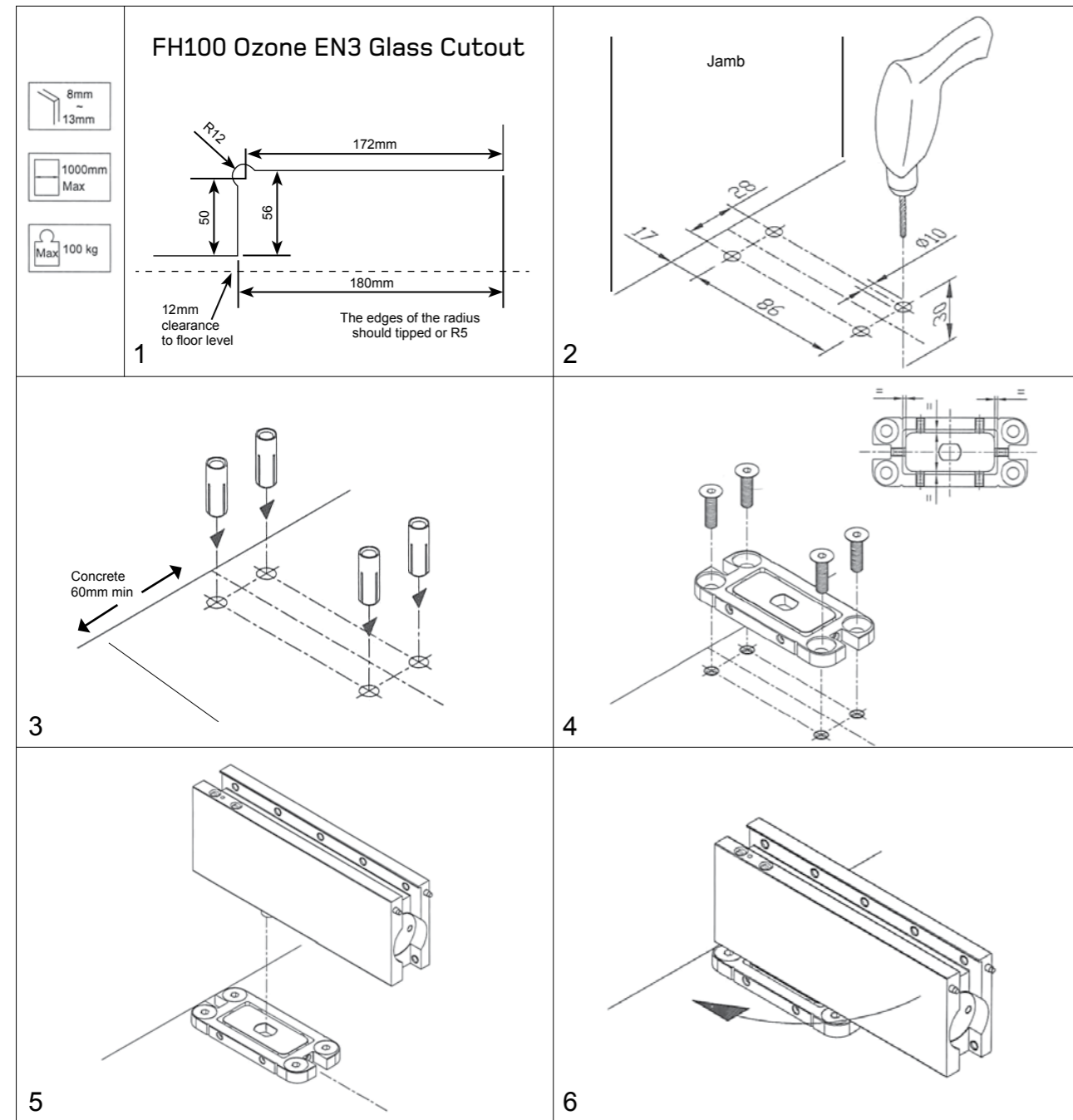

Once the patch is at 90° to the base the gaskets can be added and the door slid onto the patch and clamped in place by tightening up the screws on the side.  
The door speed and brake speed can then be adjusted to suit your requirements, then the cover caps clipped in place to complete the installation.

# FRAMELESS COMMERCIAL DOORS

## Installation / Fitting Instructions

### Ozone Plus EN3 Hydraulic Closers

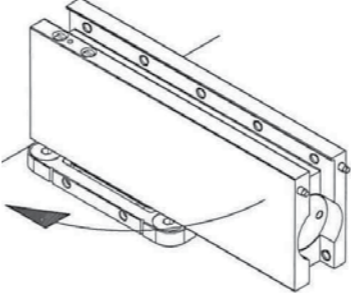
Product	Code	Description	Finish
	FH-100 HO 301076 SS 301762 PSS	Ozone Self Closing Hydraulic Patch 90° Hold Open	304 SS
	FH-100 NHO 301077 SS 301763 PSS	Ozone Self Closing Hydraulic Patch Non Hold Open	316 SS

Self closing floor mounted patch fitting for internal Frameless Glass doors up to 1000mm wide.  
Simple installation with four screw fixings into any floor. Adjustable base plate for easy alignment of the door in either direction shown in diagram below.  
Suitable for single or double action doors. Used in conjunction with standard MP20 top patch fitting. Two speed closing adjustment as shown below.  
Suits toughened frameless glass doors from 8mm - 12mm thick with a maximum door weight of 100kg's.  
Not recommended for use with Maglocks.

